

290W, 25W > Average
100% Communication
20% + Power Output



**Smart
Percium**

JA Solar Holdings Co., Ltd.

JA Solar Holdings Co.,Ltd is a world leading manufacturer of high-performance solar power products that convert sunlight into electricity for residential, commercial and utility-scale power generation. The company was founded in May 2005 and publicly listed on NASDAQ in February 2007. JA Solar has been the world's leading cell producer since 2010, and has firmly established itself as a tier 1 module supplier since 2012. Capitalizing on our strength in solar cell technology, we are committed to provide modules with unparalleled conversion efficiency, yield efficiency, and reliability to enable you to maximize your returns on PV projects. With its leading industry experience, continuous effort on R&D, customer-oriented service and sound financial status, JA Solar is your best choice of long-term trustworthy partner.

Add: Building No.8, Nuode Center, Automobile Museum East Road, Fengtai District, Beijing
 Tel: +86 (10) 63611888
 Fax: +86 (10) 63611999
 Email: sales@jasolar.com market@jasolar.com

Product Warranty

- 12-year product warranty
- 25-year linear power warranty

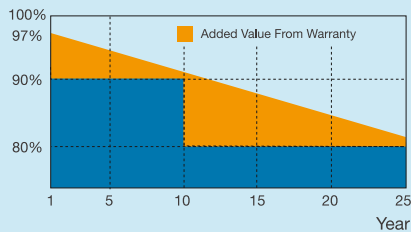

Additional Insurance Options



Partner Section

JAM60S07

280-300 1000V Percium Series

MONOCRYSTALLINE SILICON SOLAR MODULE

Key Features



JA Monocrystalline smart modules designed for residential applications, especially for rooftop market



The mono cell technology with passivated backside and local BSF, 21% average mass production efficiency



Maximum energy gain ground mounted system: 2-5%, commercial 2-10%, residential 2-25%



Automatic module shut-down Unique electrocution prevention and fire safety



Flexible system design optimal site space utilization at reduced cost



Real-time alerts module-level web monitoring Increased uptime maintenance



High salt and ammonia resistance certified by TÜV NORD

Reliable Quality

- Positive power tolerance: 0~+5W
- Potential Induced Degradation (PID) Resistant in accordance to IEC62804

Comprehensive Certificates

- IEC 61215, IEC 61730, MCS and CE
- ISO 9001: 2008: Quality management systems
- ISO 14001: 2004: Environmental management systems
- BS OHSAS 18001: 2007: Occupational health and safety management systems
- Environmental policy: The first solar company in China to complete Intertek's carbon footprint evaluation program and receive green leaf mark verification for our products



Specifications subject to technical changes and tests. JA Solar reserves the right of final interpretation.

JAM60S07 280-300/PR

1000V Percium Series

System Architecture

JA smart system components work together with any inverter to maximize energy harvest. JA smart modules can communicate by electrical line, allowing users to monitor system performance in real time.

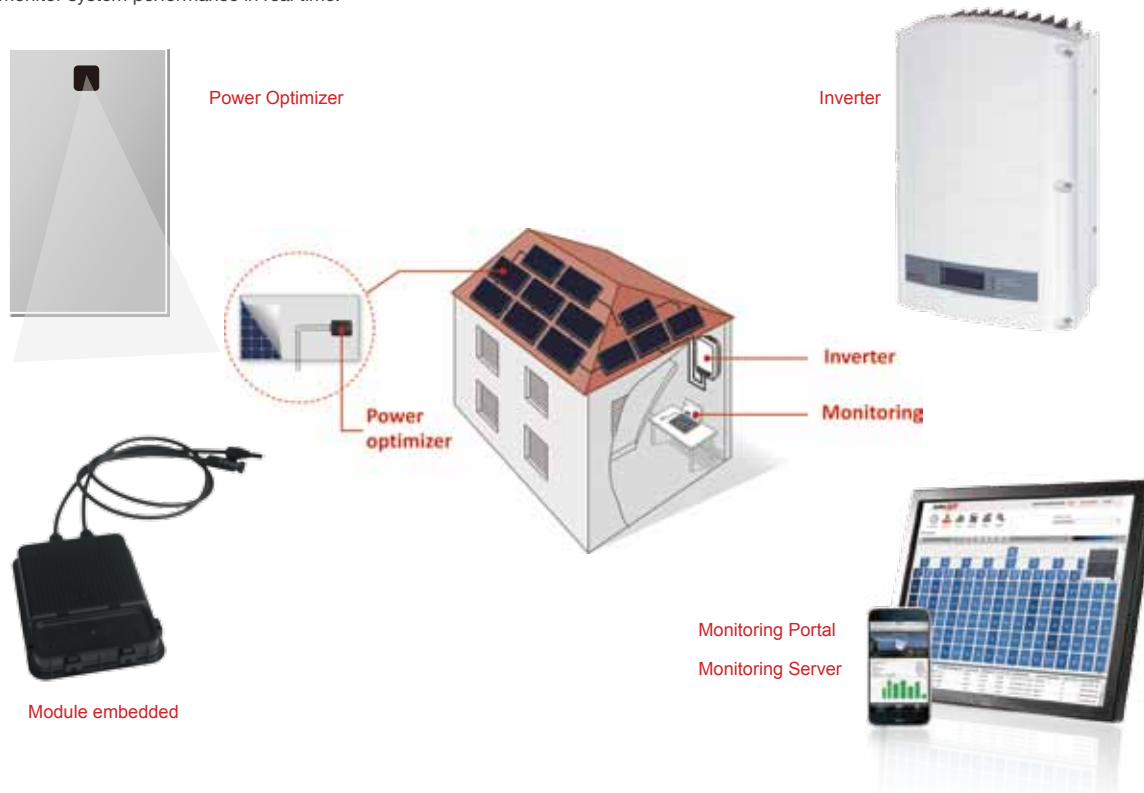

String Lengths (computed automatically by SolarEdge Site Designer)						
Module Power		280	285	290	295	300
MINIMUM string size with SolarEdge inverter	1ph	8				
	3ph	16				
	3ph-MV	18				
MAXIMUM string size with SolarEdge inverter	1ph	18	18	18	17	17
	3ph	40	39	38	38	38
	3ph-MV	45	44	43	43	43
String size with Non-SolarEdge	According to inverter design rules					

Output Voltages and Currents		
Operating Output Voltage when connected to SolarEdge Inverter	5-60	Vdc
Operating Output Voltage when connected to Non-SolarEdge Inverter	5-Voc of module	Vdc
Maximum Output Current when connected to SolarEdge Inverter	15	Adc
Maximum Output Current when connected to Non-SolarEdge Inverter	10	Adc
Output in Standby mode with SolarEdge inverter or with SMI and Non-SolarEdge inverter (when disconnected from inverter or inverter off)	1	Vdc

Standard Compliance	
Fire Safety	VDE-AR-E 2100-712:2013-05
PV Junction Box Safety	IEC62109-1 (class II safety, TUV-SUD), UL1741 (TUV-Rheinland & CSA)
PV Junction Box	EN50548 (TUV-SUD), UL3730 (TUV-Rheinland & CSA)

JAM60S07 280-300/PR

1000V Percium Series

MECHANICAL DIAGRAMS

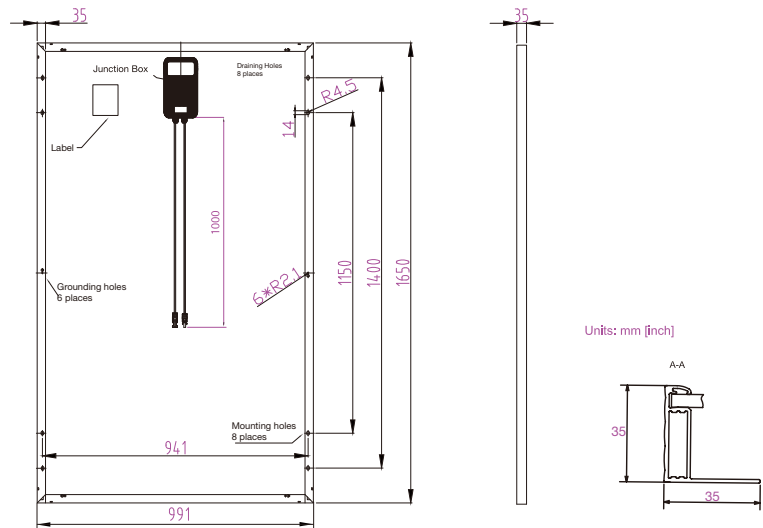
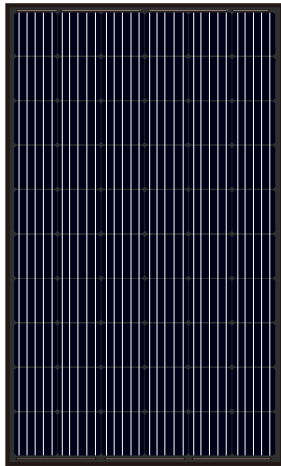

SPECIFICATIONS

Cell	Almost Full Square 156.75×156.75mm
Weight	18.5kg±3%
Dimensions	1650×991×35mm
Cable Cross Section Size	6mm ²
No. of Cells and Connections	60 (6×10)
Junction Box	Solar edge smart J-Box
Connector	MC4
Packaging Configuration	30 Per Pallet

OPERATING CONDITIONS

Maximum System Voltage	1000V DC (IEC)
Operating Temperature	-40°C~+85°C
Maximum Series Fuse	20A
Maximum Static Load, Front	5400Pa
Maximum Static Load, Back	2400Pa
NOCT	45±2°C
Application Class	Class A

ELECTRICAL PARAMETERS AT STC

TYPE	JAM60S07 -280/PR	JAM60S07 -285/PR	JAM60S07 -290/PR	JAM60S07 -295/PR	JAM60S07 -300/PR
Rated Maximum Power (Pmax) [W]	280	285	290	295	300
Open Circuit Voltage (Voc) [V]	39.05	39.25	39.46	39.64	39.85
Maximum Power Voltage (Vmp) [V]	31.60	31.70	31.80	32.03	32.26
Short Circuit Current (Isc) [A]	9.38	9.46	9.57	9.66	9.75
Maximum Power Current (Imp) [A]	8.86	8.99	9.12	9.21	9.30
Module Efficiency [%]	17.12	17.43	17.74	18.04	18.35
Power Tolerance	-0~+5W				
Temperature Coefficient of Isc (α _{Isc})	+0.060%/C				
Temperature Coefficient of Voc (β _{Voc})	-0.300%/C				
Temperature Coefficient of Pmax (γ _{Pmp})	-0.390%/C				
STC	Irradiance 1000W/m ² , cell temperature 25 °C, AM 1.5G				

CHARACTERISTICS

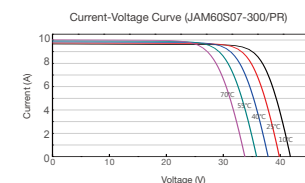
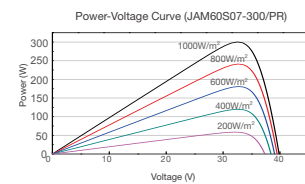
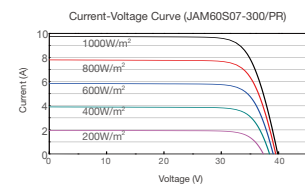

ELECTRICAL PARAMETERS AT NOCT

TYPE	JAM60S07 -280/PR	JAM60S07 -285/PR	JAM60S07 -290/PR	JAM60S07 -295/PR	JAM60S07 -300/PR
Max Power at STC (Pmax) [W]	205	209	213	217	221
Open Circuit Voltage (Voc) [V]	35.92	36.11	36.34	36.57	36.75
Max Power Voltage (Vmp) [V]	29.17	29.37	29.56	29.63	29.69
Short Circuit Current (Isc) [A]	7.45	7.53	7.61	7.69	7.78
Max Power Current (Imp) [A]	7.04	7.13	7.21	7.32	7.43
NOCT	Irradiance 800W/m ² , ambient temperature 20°C, wind speed 1m/s, AM 1.5G				



Electrical data in this catalog do not refer to a single module and they are not part of the offer. They only serve for comparison among different module types.